

Article number: 01010411
 Description: Retaining ring A 24 DIN 471
 Stainless 411
 Note: Fitted with ZGA pilers

Measures

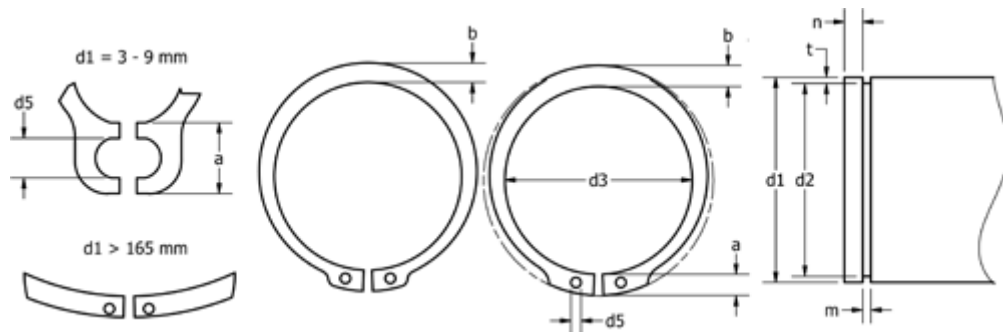

a max	= 4.4	FN kN	= 6.7	s	= 1.20
AN mm ²	= 40.5	FRg kN	= 3.65	t	= 0.55
b	= 3.0	FR kN	= 16.10	tol	= -0.21
d1	= 24	g	= 1.5	tol	= -0.06
d2	= 22.9	K kN-mm	= 33.40	tol	= +0,21-0,42
d3	= 22.2	m min	= 1.30	Tong	= ZGA-2
d5 min	= 2.0	n abl x 1000	= 27.0	Weight kg/1000	= 1.770
Description	= A24	Nominal drive	= 1.7		